

**MXL**

**FIMAP**



**POWER IN AN EXTRA LARGE SIZE**

 **FIMAP**<sup>®</sup>

# MxL



## The scrubbing machine that changes the user experience from the very first glance

The shape of the machine inspires a sense of safety and control, thanks to the harmonious and balanced design that promises a user experience that is out of the ordinary. MxL has the power you need to work in any environment and under the most difficult conditions, as a result of its careful design, which combines high-performance components with the most advanced technology.

As soon as you turn it on, you can feel the value of a machine created to enhance the professional results of every cleaning operation, with innovative features that provide operators with all the tools necessary to successfully complete their work.





# MXL

Its robust design is not afraid of any environment

The wrap-around lines delineate an enveloping structure made from polyethylene, which protects the heart of the machine and enhances its robust appearance.

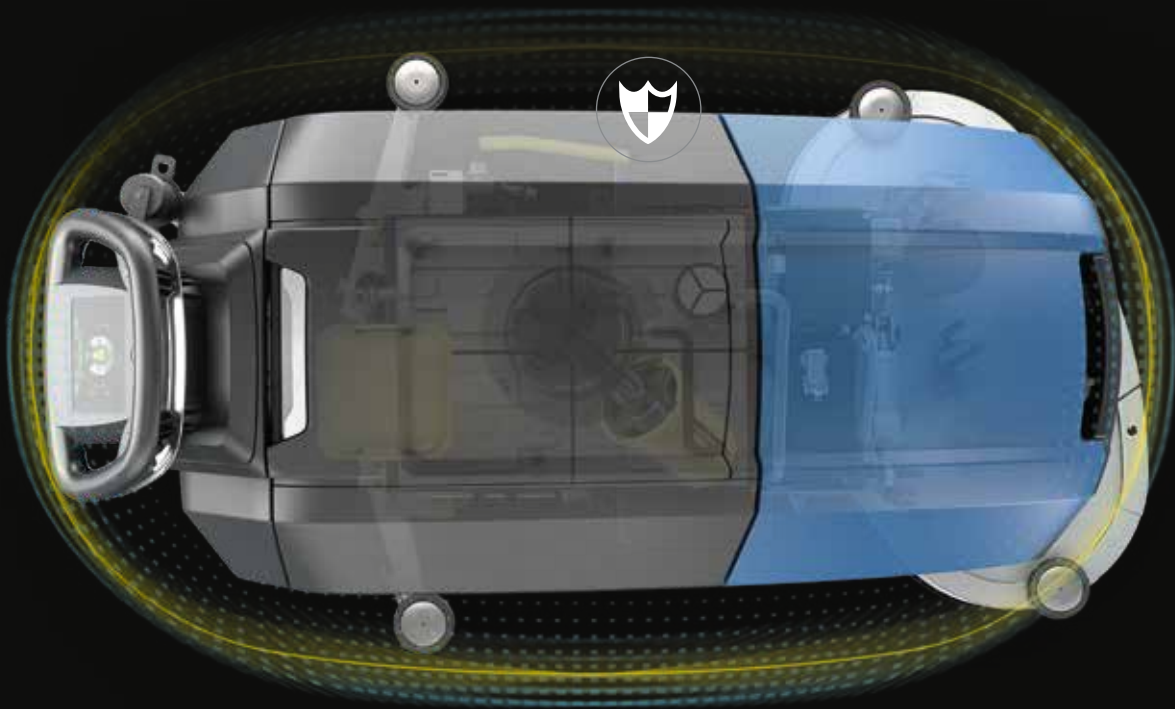

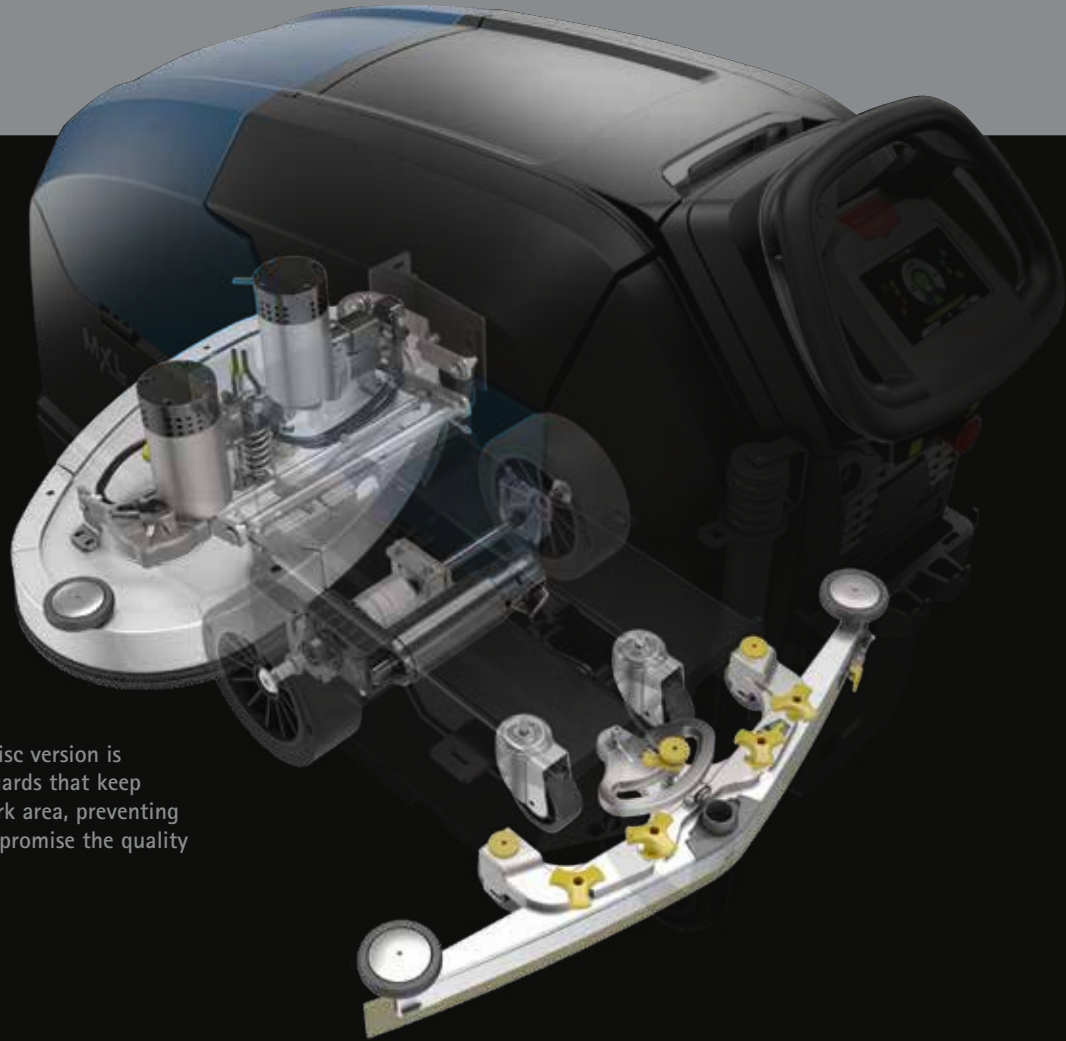

The brush head of the disc version is equipped with splash guards that keep the water inside the work area, preventing splashes that could compromise the quality of the end result.

The brush head and the squeegee are made from aluminum, a material chosen for its durability and reliability over time as well as for its lightness, to provide you with better manoeuvrability and comfort.

# MxL

## MxL gives more value to your time: it reduces downtimes and increases productivity



X

ECO  
mode

FNC

### QUIET OPERATIONS

With the Eco Mode and FNC technologies that lower the noise level, MxL safeguards the health of the operator and that of the people in the environment where it is used.

### EASY MAINTENANCE - COLOR CODED PARTS

Parts which must be cleaned at the end of every shift are color coded in yellow. Regular maintenance of these parts ensures the correct operation of the machine, along with consistent performance.



### ACCESSORY STORAGE COMPARTMENT

The operator can work in absolute tranquility in the knowledge that when he needs them, all the accessories are close at hand, and once finished with, these can easily be placed back in their compartment, allowing the cleaning operation to proceed without long interruptions and wasted time.



### FFF - FIMAP FAST FILL

Automatic system for filling the fresh water tank, lets the operator perform other activities while the tank quickly fills up.

## NO TRAINING

No doubt will keep you from your work. The integrated video tutorials on the display demonstrate how to perform routine and extraordinary maintenance, to prevent uncertainty and wasted time.



The spray gun has a dual role. During machine maintenance, it facilitates the rinsing of the tanks at the end of the shift, but it can also be used during the work, to moisten stubborn dirt stains and make them easier to remove.



Powerful and versatile, it is always ready to meet your goals



## POWER MODE

When performing localized heavy duty cleaning, pressing the Power mode function activates a work mode that uses all the scrubbing parameters to the maximum, for a short period of time. This enables the machine to act with greater force on a specific area just for the time needed, without wasting resources and having to resort to passing over the area more than once.

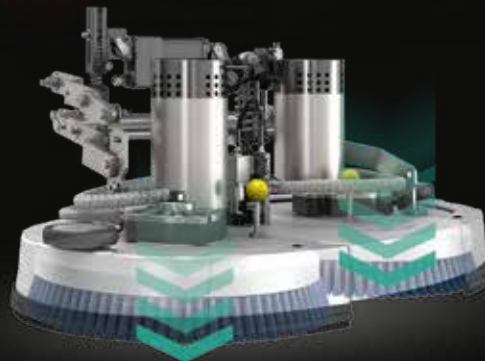





### Consistent cleaning results

Pressure on the brushes is kept constant, delivering consistent high cleaning results on any type of flooring.



### No risk of slipping

The powerful 3-stage vacuum motor leaves the floor immediately dry and safe.



### VACUUM WAND

Vacuum wand allows to clean areas that are out of reach of the machine and successfully fulfill the task.



**FLR-FIMAP LONG RANGE**  
Increases productivity by up to 70%.

**Great autonomy**  
Work for up to 5 hours non-stop.





## Equipped to give you safety and protection

The equipment on the MxL prevents accidents, increases safety while working and supports the operator at all times, so that everything is always under control, without ever encountering difficulties.

### ACTIVE TECHNOLOGIES to prevent accidents



Enhances visibility  
in dim light.



TOUCH SCREEN  
DISPLAY

For a fast operator  
training and reduced cost  
to clean.



VIDEO  
TUTORIALS

Control device letting  
the operator set the  
required speed.



CRUISE CONTROL



Maximize work safety in  
all conditions.

LED HEADLIGHTS

Automatically operated  
when the machine stops  
It works as a safety parking brake.



ELECTROBRAKE



SOS MxL

## PASSIVE SYSTEMS to help the operator in case of emergency



SOS DEVICE

Reduces time to service in case of emergency. The red button sends an SMS alert to receive prompt help, reducing downtimes.



EMERGENCY  
STOP

By pressing a single button the machine stops immediately.

# MXL



iD-intelligent Drive



TOUCH SCREEN  
DISPLAY



LOG-IN WITH  
PASSWORD



ZONE PROGRAMS



CRUISE  
CONTROL



SUSTAINABLE  
CLEANING



SEVERE  
CLEANING



VIDEO  
TUTORIALS

# You will feel like you have always known how to use it

The color interface is so user-friendly that it needs no explanation, just a glance is all it takes to have everything under control. Through the touch screen, you can explore all the solutions of the iD – intelligent Drive system, which will make every operation unique.



**LOG-IN WITH PASSWORD**  
To protect your investment



**ZONE PROGRAMS**  
For all the performance you'll ever need



**ECO MODE**  
To protect the environment



**POWER MODE**  
For maximum power when you need it



**VIDEO TUTORIALS**  
For a more efficient, fast and easy operator training



## EXPERIENCE CONNECTIVITY

Discover the FFM universe and experience the advantages of being constantly connected, with My.Machine app!

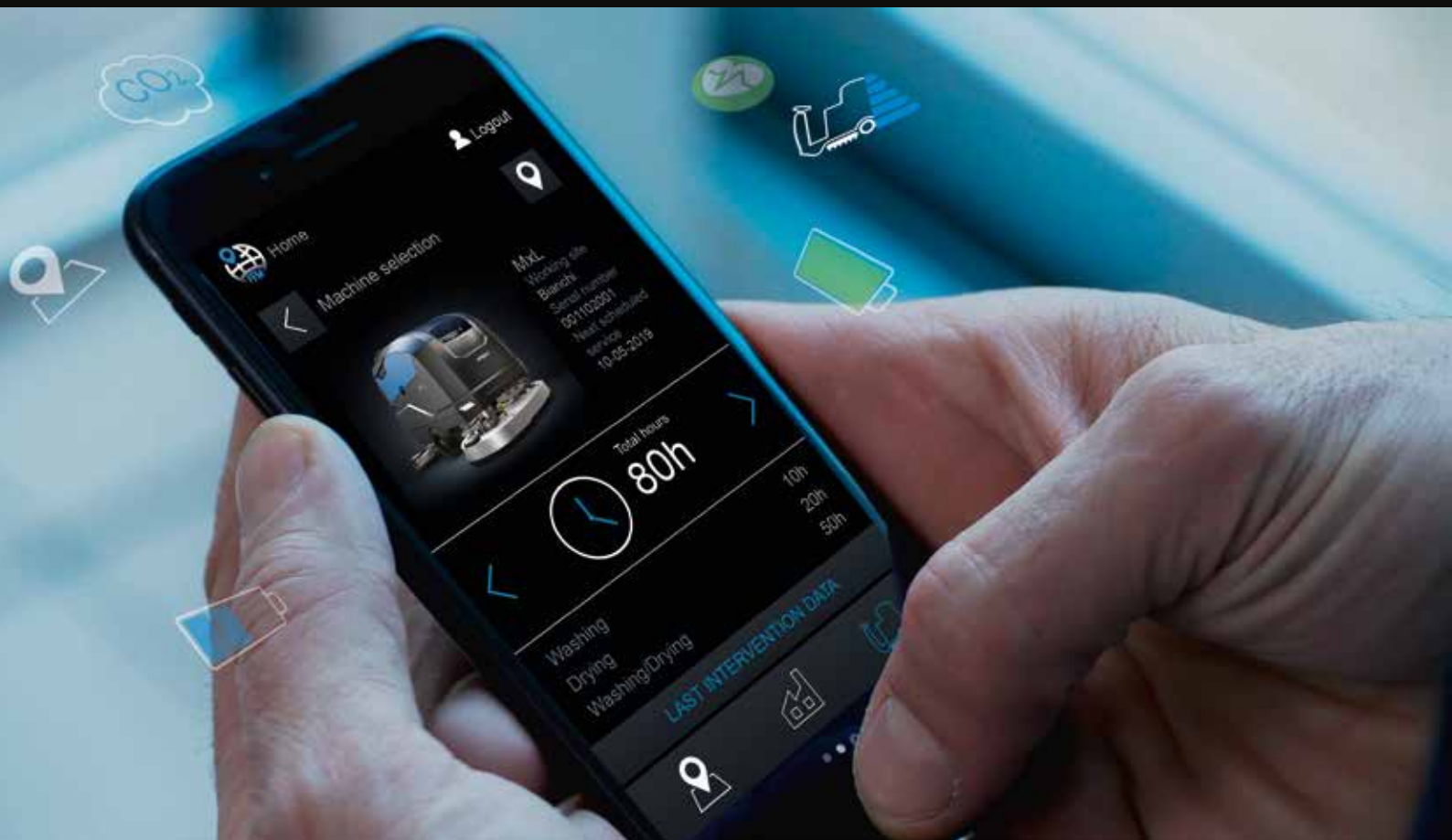



Watch the video



FIMAP FLEET MANAGEMENT

## Keep tabs on your machines remotely when you want and from wherever you want!

Developing new technology to improve efficiency is one of the core missions of Fimap.

An example of this is FFM, the Fimap Fleet Management system which collects the data sent by the machines and transforms it into valuable information accessible to you easily in real time, 24/7, from your smartphone, through the app My.Machine.

Being constantly connected to your machines will help you operate them even more efficiently and effectively. My.Machine lets you know where the machines are, if the operation is being carried out according to plans and at the scheduled time.

The machine's health status is constantly monitored. In the very unlikely event of a breakdown, you'll receive an alert notification directly on your smartphone, allowing you to take action promptly and immediately call the technical support.

You can check the battery conditions and the quality of the charges in order to optimize battery endurance and life cycle.



### GEOLOCALISATION

You know where your machines are



### USAGE INFORMATION

You know how your machines are used



### HEALTH STATUS

You know the health status of machines and batteries



### ENVIRONMENTAL IMPACT

You can check the machine consumption per intervention



## Protect the environment with efficient management of resources

With better management of resources, you can clean more sq.m with the same levels of consumption, avoiding waste. Fimap technologies optimize the use of water, detergent and energy to protect the environment and reduce the cost of cleaning per sq.m.



The Eco Mode function helps prevent water, detergent and energy consumption by using only the quantities you need and nothing more.



START&STOP

When the machine is idle, the brush motor, the vacuum motor\*, the traction and the water flow will turn off automatically, reducing costs and emissions. All the functions are reactivated automatically when the operator presence control is operated.

\* In basic and Pro versions suction turns off when the squeegee is lifted up

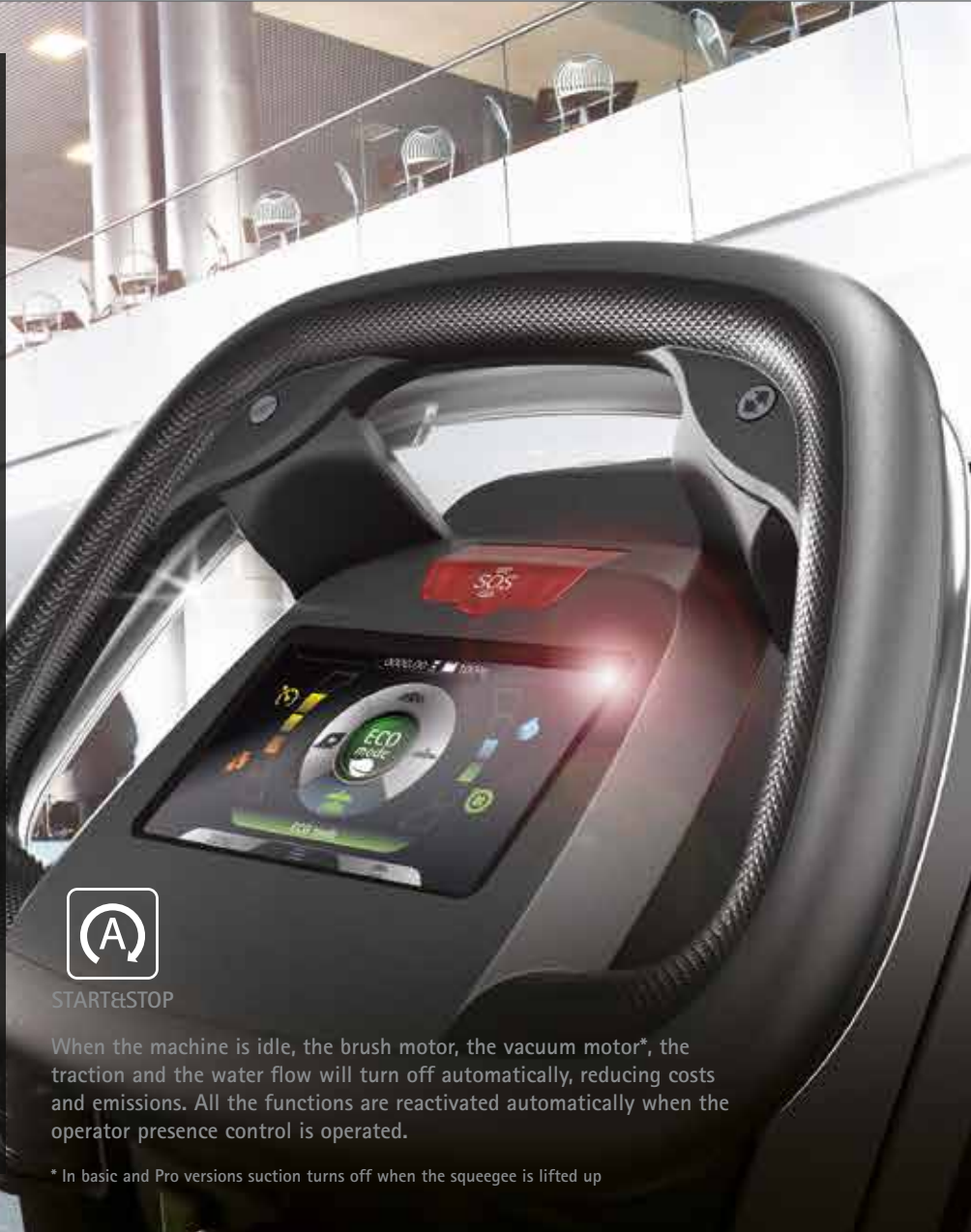



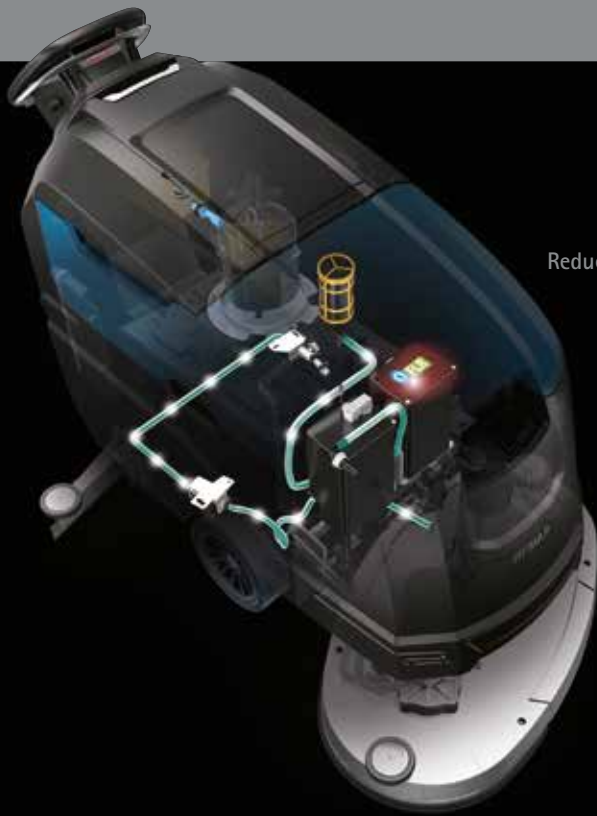

## WATER



### FLR-FIMAP LONG RANGE

Reduces water and detergent consumption per cleaning operation by up to 66%\*  
This is a system which recycles detergent solution to increase autonomy:  
to scrub more sq.m. while using less resources.



### FSS-FIMAP SOLUTION SAVER

Water and detergent quantities are separately dosed,  
reducing consumption by up to 50%.



### FWF-FIMAP WATER FLOW

Ensures uniform cleaning results across the entire working  
width on the first pass, optimizing detergent solution consumption.

## ENERGY



### FES-FIMAP ENERGY SAVER

Reduces energy consumption by up to 35%.

### LED TECHNOLOGY

Up to 80% lower energy consumption than conventional headlights.  
The LED headlights consume much less energy than conventional headlights, offer a  
longer lifespan and illuminate with a brilliant white light similar to natural daylight.



## NOISE LEVELS



### FNC-FIMAP NOISE CANCELLING

Reduces sound pressure.

\*Saving calculated on a triple recycling cycle



Make it perfect for you:  
configure it with the characteristics  
that are ideal for your needs

## Choose your machine



DISC  
with 2 disc brushes  
or 2 pad holders.



CYLINDRICAL  
with 2 cylindrical brushes  
and a debris hopper  
for small sized solid debris.



LIGHT

MEDIUM

HEAVY



#### MxL DISC

The brush head with disc brushes is the most versatile option, as this can adapt to all types of hard floors, both smooth and irregular, in any environment. The force of the two brushes easily removes even stubborn dirt.



#### MxL CYLINDRICAL

The brush head with cylindrical brushes combines the scrubbing action with a sweeping action, which reduces the operation time when it comes to cleaning floors on which small solid residues are present, avoiding the need to sweep before scrubbing.

The residues are collected in a drawer installed at the rear of the brush head, which is removable for emptying.



With flexible equipment options, you can configure it in the most convenient and beneficial way for you

Choose the instrument panel



Basic

**PRO**

**PLUS**



Membrane  
control panel

Touch screen  
display

# OPTIONALS AND ACCESSORIES

## OPTIONALS



Vacuum wand



Spray gun



FFF – FIMAP FAST FILL



FFM-FIMAP FLEET MANAGEMENT



Front driving LED headlights



FSS-FIMAP SOLUTION SAVER



Battery charger on board



Squeegee holder accessory

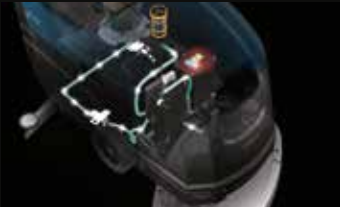

FLR-FIMAP LONG RANGE

## ACCESSORIES

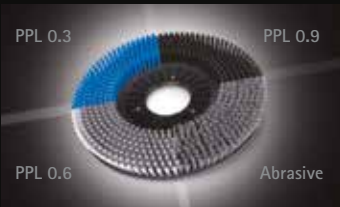

A wide choice of disc or cylindrical brushes in PPL is offered, available in thicknesses from 0.3 to 0.9 cm. These offer the perfect solution for dealing with any type of dirt on any floor.

**Abrasive brushes:**  
Ideal for heavy duty cleaning on industrial surfaces.



**Rear squeegee rubber blades**  
33 SHORE (PARA)  
For maintenance cleaning of smooth floors.  
40 SHORE (PARA)  
For stubborn dirt on floors with joints.  
POLYURETHANE  
For heavy duty cleaning on industrial floors, even with wide gaps.



# OPTIONAL AND STANDARD EQUIPMENT

USER EXPERIENCE	DUAL DISC									CYLINDRICAL		
	65 Bt	65 Bt Pro	65 Bt Plus	75 Bt	75 Bt Pro	75 Bt Plus	85 Bt	85 Bt Pro	85 Bt Plus	70 Bts	70 Bts Pro	70 Bts Plus
iD-Intelligent Drive:	-	-	•	-	-	•	-	-	•	-	-	•
- 5 inch high resolution colour touch screen	-	-	•	-	-	•	-	-	•	-	-	•
- Log-in with password	-	-	•	-	-	•	-	-	•	-	-	•
- Zone programs	-	•	•	-	•	•	-	•	•	-	•	•
- Cruise control	-	•	•	-	•	•	-	•	•	-	•	•
- Eco Mode	•	•	•	•	•	•	•	•	•	•	•	•
- Power Mode	-	-	•	-	-	•	-	-	•	-	-	•
- Video tutorials	-	-	•	-	-	•	-	-	•	-	-	•
Membrane control panel	-	•	-	-	•	-	-	•	-	-	•	-
<b>COMFORT</b>												
Hour meter	•	•	•	•	•	•	•	•	•	•	•	•
Cleaning solution level indicator	•	•	•	•	•	•	•	•	•	•	•	•
Fresh water empty tank light	-	-	•	-	-	•	-	-	•	-	-	•
Battery charger	○	○	○	○	○	○	○	○	○	○	○	○
Brush and squeegee actuator	-	-	•	-	-	•	-	-	•	-	-	•
Brush head actuator	-	•	-	-	•	-	-	•	-	-	•	-
Brush head manual lifting	•	-	-	•	-	-	•	-	-	•	-	-
Squeegee manual lifting	•	•	-	•	•	-	•	•	-	•	•	-
Vacuum wand with 3-stage motor*	-	○	○	-	○	○	-	○	○	-	○	○
Spray gun*	-	○	○	-	○	○	-	○	○	-	○	○
Squeegee holder accessory	○	○	○	○	○	○	○	○	○	○	○	○
FFF (Fimap Fast Fill)	-	○	○	-	○	○	-	○	○	-	○	○
Noiseless suction	-	•	-	-	•	-	-	•	-	-	•	-
<b>PRODUCTIVITY</b>												
Water flow selector	-	•	•	-	•	•	-	•	•	-	•	•
Triple pressure selector	-	-	•	-	-	•	-	-	•	-	-	•
Double pressure	-	•	-	-	•	-	-	•	-	-	•	-
FFM (Fimap Fleet Management) with SOS device	○	○	○	○	○	○	○	○	○	○	○	○
Squeegee and squeegee support in aluminum	•	•	•	•	•	•	•	•	•	•	•	•
Vacuum speed selector	-	-	•	-	-	•	-	-	•	-	-	•
<b>SAFETY</b>												
Driving LED headlights (front)	○	○	•	○	○	•	○	○	•	○	○	•
Emergency Stop	•	•	•	•	•	•	•	•	•	•	•	•
Electro parking brake	•	•	•	•	•	•	•	•	•	•	•	•
<b>ENVIRONMENT</b>												
FSS (Fimap Solution Saver)**	-	○	○	-	○	○	-	○	○	-	○	○
FLR (Fimap Long Range)**	-	○	○	-	○	○	-	○	○	-	○	○
FNC (Fimap Noise Canceling)	•	-	-	•	-	-	•	-	-	•	-	-
FES (Fimap Energy Saver)	•	•	•	•	•	•	•	•	•	•	•	•
FWF (Fimap Water Flow)	•	•	•	•	•	•	•	•	•	-	-	-
Start&Stop	•	•	•	•	•	•	•	•	•	•	•	•

\* In PRO versions the two devices cannot be installed together

\*\* The two devices cannot be installed together

• STANDARD

○ UPON REQUEST

- NOT AVAILABLE

# DIMENSIONS AND TECHNICAL DATA

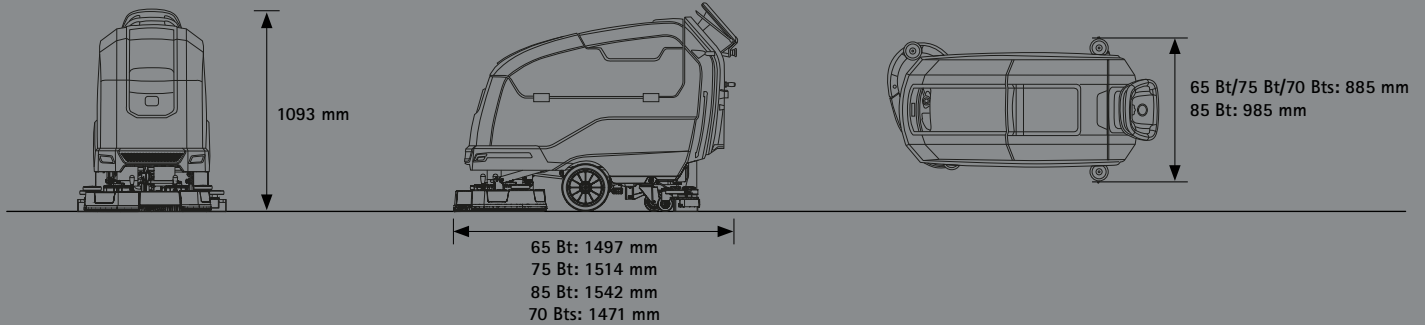

TECHNICAL DATA - MxL		DUAL DISC									CYLINDRICAL		
		65 Bt	65 Bt Pro	65 Bt Plus	75 Bt	75 Bt Pro	75 Bt Plus	85 Bt	85 Bt Pro	85 Bt Plus	70 Bts	70 Bts Pro	70 Bts Plus
Productivity theoretical	up to sqm/h	2620			3000			3400			2580		
Estimated coverage	up to sqm/h	1638			1913			2100			1613		
<b>SCRUBBING SYSTEM</b>													
Working width	mm	655			765			840			645		
Brushes motors	(no.) V/W				(2) 24/500						(2) 24/450		
Brushes rpm	rpm/min				140						550		
Pressure on the brushes (min. - med. - max)	kg	33	33÷55	33÷45÷55	35	35÷57	35÷45÷57	38	38÷60	38÷45÷60	33	15÷40	15÷30÷40
<b>TANKS AND RECOVERY SYSTEM</b>													
Solution tank	l				74								
Recovery tank	l				85								
Suction motor	V/W				24/422								
Vacuum water lift	mbar				112								
3-stage vacuum motor (for vacuum wand)	V/W	-	24/680	-	24/680	-	24/680	-	24/680	-	24/680	-	24/680
Vacuum water lift (3-stage motor)	mbar	-	166	-	166	-	166	-	166	-	166	-	166
Detergent tank capacity (FSS)	l				3								
Maximum volume of the debris hopper	l				-						8		
<b>BATTERIES</b>													
Supply/traction	V				24/aut.								
Batteries	(no.) V/Ah C5				(4) 6/180 GEL						(4) 6/210 WET		
Battery run time*	up to h	5	4,4	5	4,4	5	4,4	5	4,4	5	4,5	5	4,5
<b>PROPELLING SYSTEM</b>													
Forward working speed	km/h				4								
Transport speed	km/h				4,9								
Traction motor	V/W				(1) 24/300								
<b>SPECIFICATIONS</b>													
Machine dimensions (l x h x a)	mm	1497 1093 701			1514 1093 795			1542 1093 878			1471 1093 733		
Squeegee width	mm	785			885			985			885		
Machine weight empty without batteries	kg	186	191	188	193	191	196	187	192				
Machine weight empty with batteries	kg	310	315	312	317	315	320	311	316				
GVW (Gross Vehicle Weight)	kg	387	400	389	402	392	405	388	410				
Sound level (ISO 11201)	dB (A)				<70								

\* Run times are based on continuous scrubbing run times

# FIMAP LIFE

Your best investment in cleaning

The service package that gives you more of what you need for less than you think!  
We want you to deal only with your work, leave everything else to Fimap Life!

## FIMAP INTELLIGENCE



Using powerful software, unique of its kind, and on-site advice, Fimap supports you in choosing the ideal model and its optimum configuration, according to the type of environment to be cleaned and your requirements.

## FIMAP FINANCE



Fimap offers various financial solutions that can be adapted perfectly to your business.

## FIMAP MAINTENANCE



With Fimap Maintenance you will not have to worry about maintenance of the product: your Fimap machines will always be as new and ready for use. Choose from the three Service Packs offered - Light, Smart or Full - to suit the needs of your job.

## FIMAP FLEET MANAGEMENT



Fimap Fleet Management (FFM) service transforms the data received from the machines into information that is essential to improve the performance and productivity of the fleet. Through the app My.Machine it provides a comprehensive overview of the machines in use, helping you to reduce costs and optimize cleaning times.

## FIMAP NETWORK



Fimap is always there for you: our global network of certified dealers guarantees a rapid response support service, wherever you are.

## FIMAP ACADEMY



In a market that is becoming more and more competitive, Fimap offers a new support service for cleaning contractors, a growth opportunity for the professionals of today and tomorrow. This dedicated training program addresses various subjects that are relevant for the daily requirements of customers.

### CERTIFICATIONS

Mapping Your Green Products  
**greenmap**



For any additional information or for a demo please contact your usual Fimap dealer

  
www.fimap.com

FIMAP spa – Via Invalidi del Lavoro, 1 – 37059 S. Maria di Zevio – Verona – Italy  
Tel. +39 045 6060411 – Fax +39 045 6060417 – E-mail: fimap@fimap.com

Numero Verde  
**00800-05070000**



Scan the QR Code  
with your Smart Phone  
and visit our web-site